

STEP 3

Attach Top & Bottom Panel (A) to the completed unit in Step 2 using Screw (1).

Note: The side of Top & Bottom Panel with back hanging piece should face same direction.

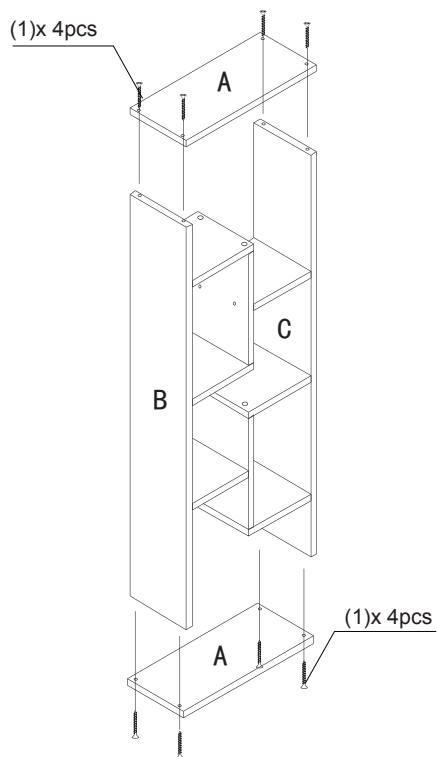

STEP 4

4.1 Cover Sticker (4) on exposed screws for neat appearance.

4.2 Hang completed unit to the wall with Wall Screw/Plastic Anchor (5).

You can hang it either vertically or horizontally.

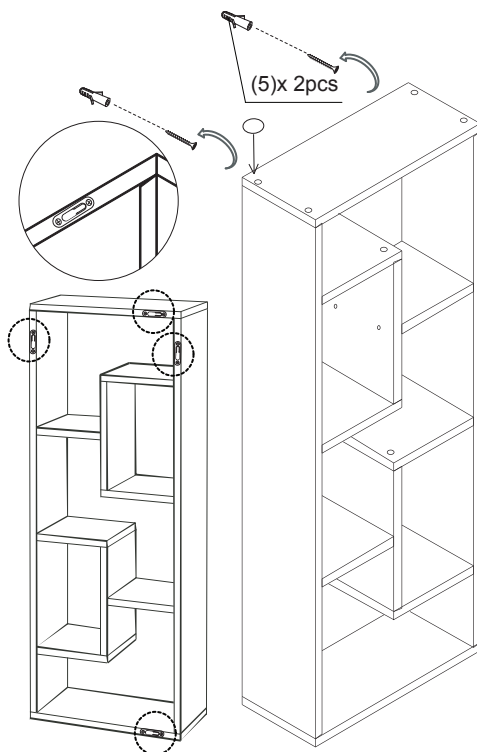

Recommended Maximum Weight

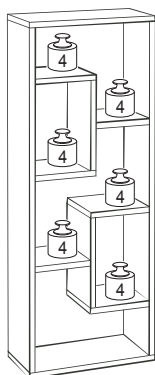

*Unit in Pound(lbs)

WARNING:

>This unit has been designed to support the maximum loads shown. Exceeding these load limits could cause sagging, instability, product collapse, and/or serious injury.

>DO NOT allow children to climb on unit.

>Put heavier items on lower shelves.



Assembly Instruction

Furinno Boyate Five Wall Mounted Shelf

MODEL : **FNAJ-11033**

DIMENSION : 13.6"(W) x 36.1"(H) x 5.9"(D)

00:20

Approx. 20 minutes



Recomm. 1 Person



Tool Required

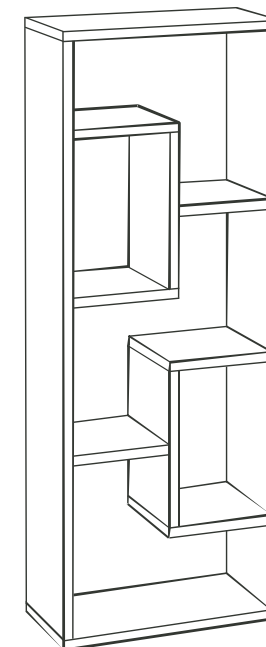

Customer Service

Tel/Fax: 281.500.9372





Toll Free: 773.299.8111 (Mon - Fri 9am - 5pm)





Email: support@furinno.com

www.furinno.com

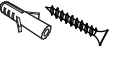
Find us on
Facebook

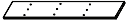
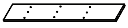
Pinterest

No	Hardware List	Qty
1	Screw 	20pcs
2	Wood Dowel 	12pcs
3	Cam-Lock Screw/Nut 	6pcs
4	Sticker 	20pcs
5	Wall Screw/ Plastic Anchor 	2pcs

No	Parts List	Qty
A	Top & Bottom Panel 	2pcs
B	Left Side Panel 	1pcs
C	Right Side Panel 	1pcs
D	Center Panel 	2pcs
E	Long Shelf Panel 	4pcs
F	Short Shelf Panel 	2pcs

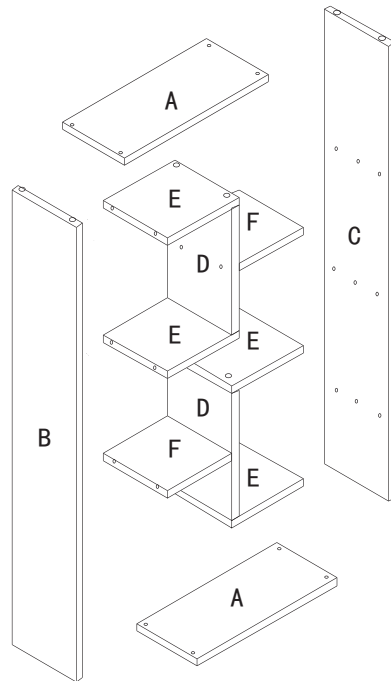

USEFUL HINTS BEFORE YOU START:

1. Read each step carefully before starting.
2. It is important that each step is performed in correct order to avoid difficulties.
3. Identify, sort and count the parts before assembly.
4. Assemble your furniture on packaging cardboard to prevent scratch or damage.
5. Clean the product with mild cleanser using soft damped cloth. Do not use harsh or abrasive cleanser.
6. Using incompatible hardware might cause damage to product.

STEP 1

Attach Short Shelf Panel (F) and two piece of Long Shelf Panel (E) to Center Panel (D) using Screw (1).

****Repeat this step twice with the other set of panels.****

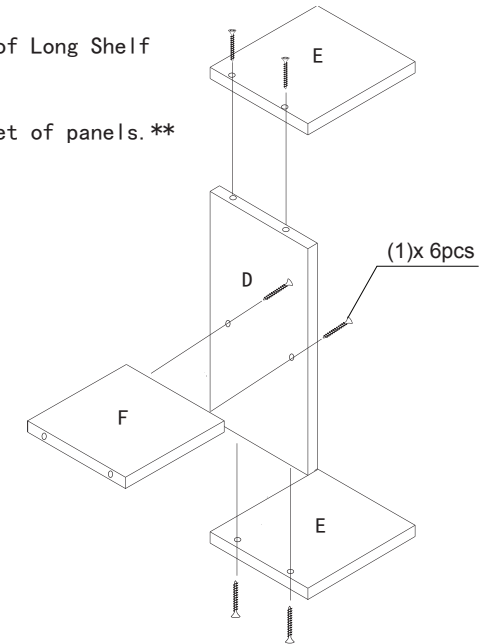

STEP 2

Attach L/R Side Panel (B)&(C) to the completed unit in Step 1 using Cam-Lock Screw/Nut (3) and Wood Dowel (2).

Note: The side of L/R Side Panel with back hanging piece should face the same direction.

